

# ACCESSOIRES UNIVERSELS v2.0

[www.hobifrance.com](http://www.hobifrance.com)



● SILENCIEUX Euro 0-1-2-3



● SILENCIEUX CATALYTIQUE Euro 4-5-6

● TUBES



● FLEXIBLES

● ACCESSOIRES

**hobi**®

ÉCHAPPEMENTS PL  
RÉSERVOIRS D'AIR PL  
RÉSERVOIRS DE CARBURANT PL

# SOMMAIRE

COLLIERS « TORCA », « FLEX », « FILS ».....	1
COLLIERS « PLATS », « VOLVO » .....	2
COLLIERS « IVECO – MERCEDES », CLAPETS ANTI PLUIE .....	3
BRIDES « M8 », « BRIDES « M10 », SUPPORTS de BRIDES .....	4
COLLIERS en « V », « SCANIA », Embouts 42180 à souder .....	5
COUDES à 90° et 45° MÂLE – MÂLE ou MÂLE – FEMELLE .....	6
TUBES DROITS MÂLE – MÂLE, TUBES FLEXIBLES 2 mètres .....	7
TUBES FLEXIBLES 1 mètre, TUBES DROITS MÂLE – FEMELLE .....	8
TUBES COUDES – MANCHONS D'ACCOUPEMENTS .....	9
CAOUTCHOUCS DE SUSPENSION .....	10
PARE FLAMMES « PL » & « VL ».....	11
SILENCIEUX STANDARDS - FLEXIBLES ONDULEUX + TRESSE .....	12
RACCORDS 90° - PARE-CHALEUR TUBES – SANGLES SILENCIEUX.....	13



## COLLIERS « TORCA »

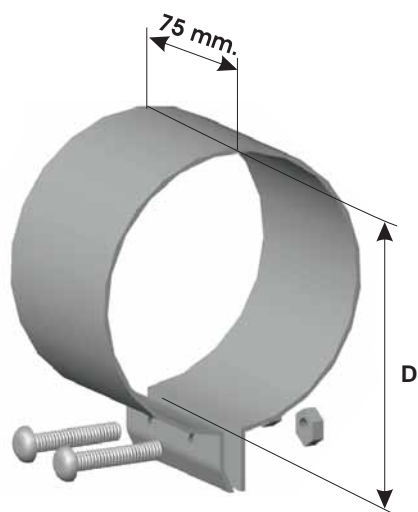

Électrozingués	Inox 304 L	Diamètres (mm)	
Réf. HOBI	Réf. HOBI	Dia. (mm)	
11739	11739T	50	
11630	11630T	57	
11646	11646T	63,5	
11609	11609T	70	
11604	11604T	76,2	
11651	11651T	88,9	
11297	11297T	101,6	
11295	11295T	108	
11282	11282T	114,3	
11270	11270T	127	
11275	11275T	138	
11233	11233T	152	

## COLLIERS « FLEX »

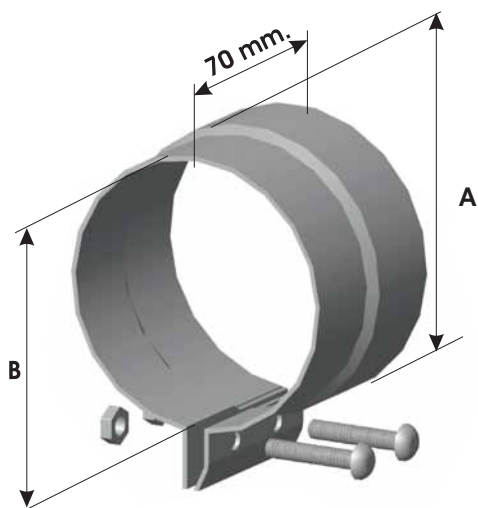

Électrozingués	Inox 304 L	Diamètres (mm)	
Réf. HOBI	Réf. HOBI	Dia. "A"	Dia. "B"
11783	11783T	55	50
11735	11735T	62	57
11748	11748T	65	60
11741	11741T	75	70
11700	11700T	81,2	76,2
11758	11758T	84	80
11719-11751	11719T	93,6	88,9
11698	11698T	105	100
11696	11696T	106,6	102,6
11695	11695T	108,0	113,0
11688	11688T	115	110
11683-59508	11683T	119	114,3
11678	11678T	125	120
11670-11675	11675T	132	128
11639	11639T	158	152

## COLLIERS « FILS »

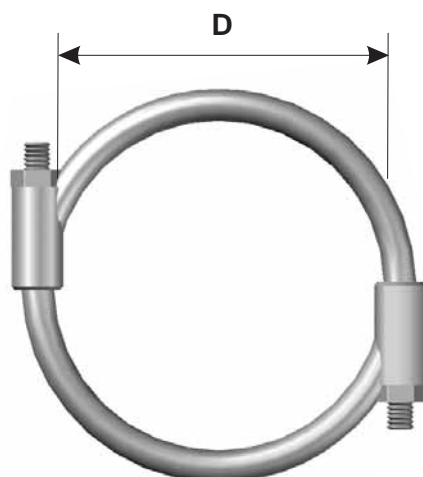

Électrozingués	
Réf. HOBI	Dia. (mm)
11957	76 - 82
11912	83 - 94
11890	95 - 107
11882	108 - 114
11881	115 - 119
11867	120 - 132
11832	142 - 154

## COLLIERS « PLATS »

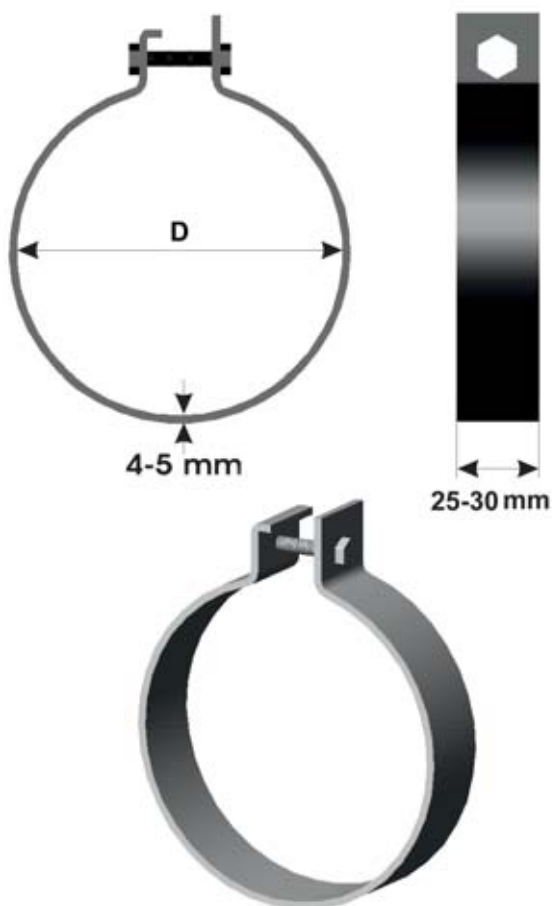

Électrozingués	
Réf. HOBI	Dia. (mm)
11023	45,5
11025	48,5
11039	50,5
11036	53,5
11033	55,5
11035	58,5
11049	60,5
11046	63,5
11043	65,5
11045	68,5
11009	70,5
11006	73,5
11003	75,5
11004	76,5
11005	78,5
11059	80,5
11053	85,5
11051	90,5
11012	94,5
11099	100,5
11097	102,5
11092	104,5
11095	108,5
11089	110,5
11082	114,5
11079	120,5
11072	124,5
11070	127,5
11069	130,5

## COLLIERS « VOLVO »



Électrozingués	
Réf. HOBI	Dia. (mm)
11927	39 - 42
11923	42 - 45
11925	45 - 48
11938	48 - 51
11933	52 - 55
11935	55 - 58
11948	58 - 61
11942	61 - 64
11940	65 - 67
11908	68 - 71
11902	71 - 74
11900	74 - 77
11956	78 - 82
11950	83 - 87
11914 - 42559	91 - 96
11899	100 - 106
11895	104 - 107
11883	108 - 114
11879	115 - 120
11870	123 - 128
11863	130 - 135
11820	142 - 147
11831	151 - 159

## COLLIERS « IVECO - MERCEDES »

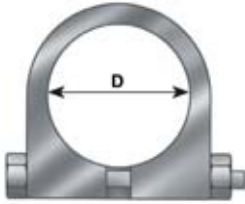
Design A 	Électrozingués		
	Réf. HOBI	Dia. (mm)	Design
	75589	59,5 - 62,5	A
	75558	63 - 66	A
	75588	65 - 68	A
	75559	67 - 70	A
	39174	74 - 77	A
	39123	76 - 79	A
	75536	80 - 83	A
	39170	87,5 - 90,5	A
	39172	92 - 96	A
	75535	97 - 100	A
	75506	102 - 105	B
	75534	104 - 107	A
	75502	106 - 110	B
	75543	114 - 118	B
	75544	118 - 122	B
	75503	128 - 132	B
	75504	131 - 135	B
	75575	146 - 151	B

Design B  

## CLAPETS ANTI PLUIE

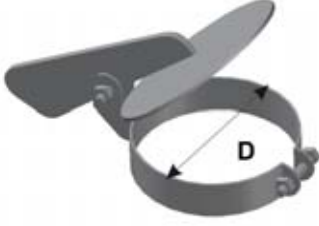
	Électrozingués			Électrozingués	
	Réf. HOBI	Dia. (mm)		Réf. HOBI	Dia. (mm)
	15980	170	15239	50,5	
	15981	193	15249	60,5	
	15982	200	15242	63,5	
	15983	219	15209	70,5	
	15984	250	15204	76,5	
	15985	300	15259	80,5	
	15986	323	15251	90	
	15987	350	15299	100,5	
	15988	400	15297	102	
	Livrés électrozingués recouverts de peinture noire. Fabrication INOX possible.		15289	110,5	
			15282	115	
			15279	120,5	
			15270	127,5	
			15229	140	
			15238	152	
			15245	160 - 168	
			15296	203	

## EXEMPLES DE MONTAGES

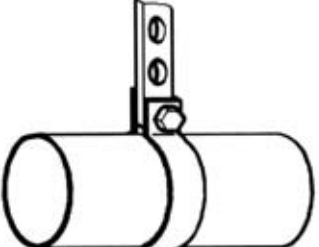
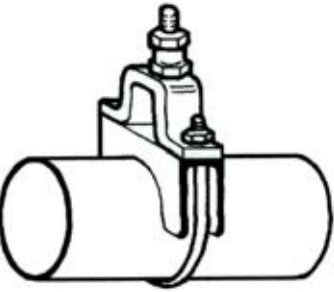
FIXER UN FLEXIBLE SUR UN TUBE	SUSPENDRE UN TUBE	FIXER UN TUBE SUR UN CHÂSSIS
		
Utiliser les colliers « VOLVO », ils ne cassent pas les spires du flexible.	Utiliser les colliers « PLATS »	UTILISER LES « BRIDES » + « SUPPORTS DE BRIDES » + « CAOUTCHOUCS »

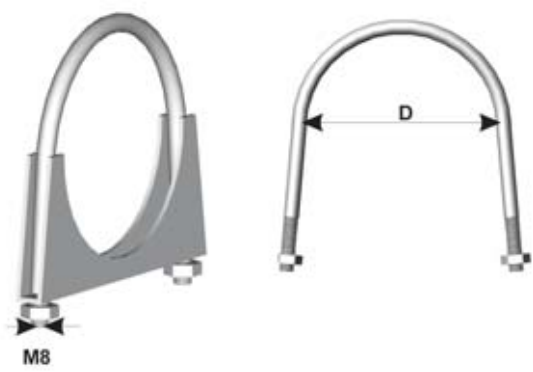

## BRIDES « M8 »

		Électrozingués			
		Réf. HOBI	Dia. (mm)	Réf. HOBI	Dia. (mm)
	19975	29	19909	70	
	19967	32	19906	73	
	19963	37	19904	76,2	
	19965	38	19901	80	
	19928	44	19956	83	
	19923	45	19951	88,9	
	19925	48	19917	92	
	19937	52	19913	95,3	
	19932	54	19897	102	
	19930	57	19894	105	
	19949	60	19882	114	
	19942	65	19870	127	
	19940	67	19871	130	

## BRIDES « M10 »

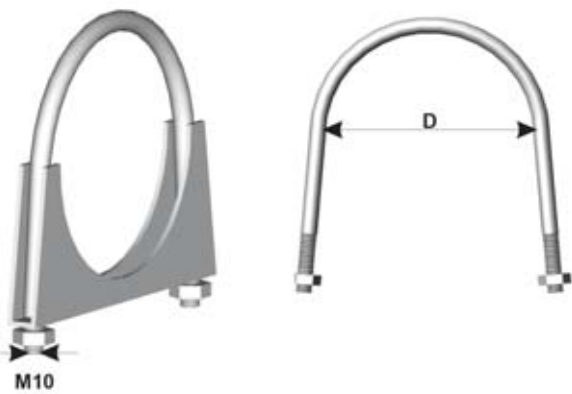
		Électrozingués	
		Réf. HOBI	Dia. (mm)
	19893	105	
	19891	109	
	19889	110	
	19879	120	
	19869	130	
	19827	142	
	19833	155	
	19843	165	

## SUPPORTS DE « BRIDES »

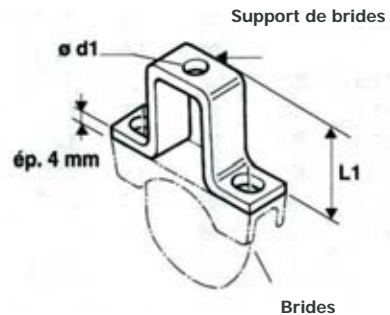
		Électrozingués			
		Pour Tubes Dia. Ext. (mm)	Réf. HOBI Brides	D1 (mm)	L1 (mm)
	50	19937	12	49	19997
	60	19949	12	49	19997
	65	19942	12	49	19997
	70	19909	12	49	19998
	75	19904	12	64	19998
	80	19901	12	64	19998
	88,9	19951	12	64	19998
	101,6	19897	14	74	19999
	110	19889	14	74	19999
	120	19879	14	74	19999

## COLLIERS EN « V »

Électrozingués	Inox 304 L	Valeurs (mm)						
		Réf. HOBI	Réf. HOBI	Dia. A	Dia. D	C	E	F
-	44592	-	44592	73	54	8	18	18
-	55548	-	55548	82	63,5	4	20	17
-	22593	-	22593	102	76,1	7	20	23,5
-	05519	-	05519	113	88,9	7	20	23,5
-	78513	-	78513	113	88,9	11	19	21
-	09592	-	09592	121	101,6	7	20	23,5
-	05596	-	05596	125	101,6	5	20	23,5
59189	-	-	59189	125	101,6	5	20	25
-	28566	-	28566	124	101,6	4	20	17
-	05583	-	05583	137	114,3	7	20	23
-	45563	-	45563	132	114,3	6	20	13,5
-	21161	-	21161	142	114,3	9	25	18
-	78514	-	78514	134	114,3	8,5	25	22
71594	-	-	71594	138	120	7	25	17
-	05575	-	05575	151	127	7	20	23,5
59178	-	-	59178	151	127	7	25	18
-	45535	-	45535	146	127	6	20	13,5
-	78539	-	78539	151	127	4	20	17
-	78593	-	78593	150	127	9	25	23
-	75193	-	75193	159	130	9	25	23

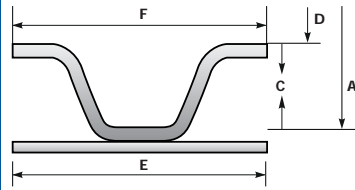

## COLLIERS « SCANIA »

Électrozingués		
Réf. HOBI	Dia. (mm)	Réf. SCANIA
45585	114 - 119	328928 - 1384745
45581	119 - 124	1300367

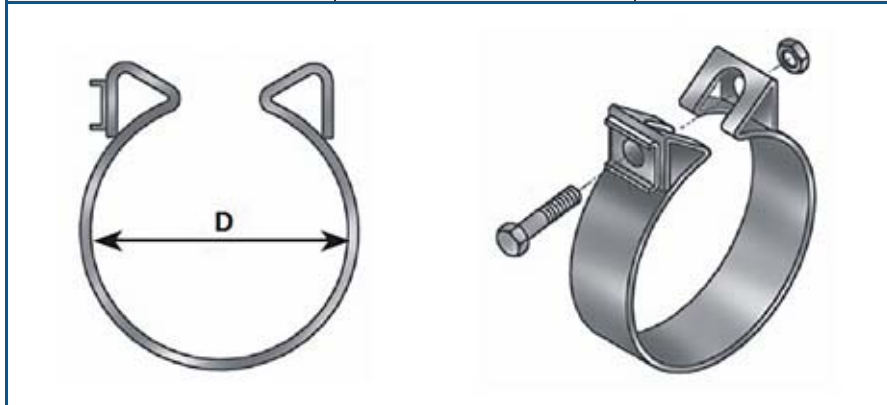

## EMBOUTS 42180 À SOUDER

Électrozingués				
Réf. HOBI Collier	Réf. HOBI Partie Mâle	Dia. Int. (mm)	Réf. HOBI Partie Femelle	Dia. Int. (mm)
42180	43115	108	43111	108

Partie mâle Réf : 43115

42180  
50.01.838.015

Partie Femelle Réf : 43111

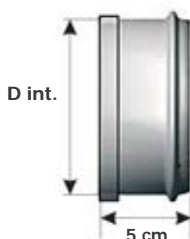

## COUDES à 90° FEMELLE - MÂLE

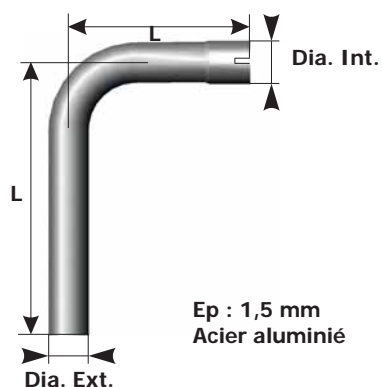

Réf. HOBI	L : (mm)	Dia. Int (mm)	Dia. Ext (mm)
18938	195	51,30	50,00
18930	240	57,60	57,10
18949	240	60,50	60,00
18942	265	64,00	63,50
18944	265	65,50	65,00
18909	270	70,30	70,00
18902	290	75,50	75,00
18904	295	76,70	76,20
18951	320	89,40	88,90
18897	380	102,10	101,60
18895	400	108,50	108,00
18889	400	110,50	110,00
18882	390	114,80	114,30
18878	410	121,00	120,00
18875	415	128,00	127,00
18827	375	141,00	140,00

## COUDES à 90° MÂLE - MÂLE

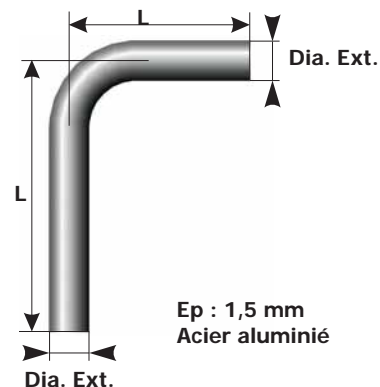

Réf. HOBI	L : (mm)	Dia. Ext (mm)
18939	190	50,00
18934	240	57,10
18931	240	60,00
18946	265	63,50
18943	265	65,00
18908	270	70,00
18906	290	75,00
18903	295	76,20
18959	205	80,00
18955	320	88,90
18899	380	100,00
18898	380	101,60
18891	400	110,00
18886	390	114,30
18879	410	120,00
18870	415	127,00
18829	375	140,00

## COUDES à 45° FEMELLE - MÂLE

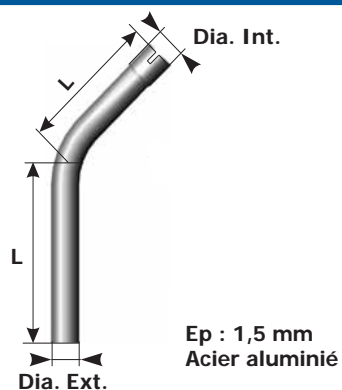

Réf. HOBI	L (mm)	Dia. Int. (mm)	Dia. Ext. (mm)
17938	140	51,30	50,00
17930	150	57,60	57,10
17949	150	60,50	60,00
17942	180	64,00	63,50
17944	180	65,50	65,00
17909	205	70,30	70,00
17902	230	75,50	75,00
17904	205	76,70	76,20
17951	225	89,40	88,90
17897	245	102,10	101,60
17895	260	108,50	108,00
17889	260	110,50	110,00
17882	260	114,80	114,30
17878	365	121,00	120,00
17875	365	128,00	127,00
17829	423	141,50	140,00

## COUDES à 45° MÂLE - MÂLE

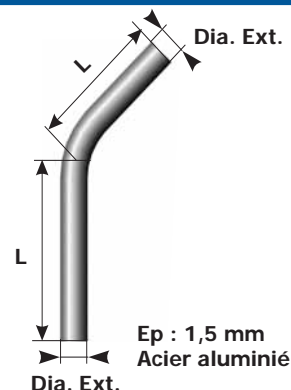

Réf. HOBI	L (mm)	Dia. Ext. (mm)
17939	140	50,00
17934	150	57,10
17931	150	60,00
17947	180	63,50
17943	180	65,00
17908	205	70,00
17903	230	76,20
17959	230	80,00
17955	225	88,90
17899	245	100,00
17898	245	101,60
17891	260	110,00
17886	260	114,30
17879	365	120,00
17870	365	127,00
17828	423	140,00



## TUBES DROITS MÂLE - MÂLE

Dia.  
Ext.

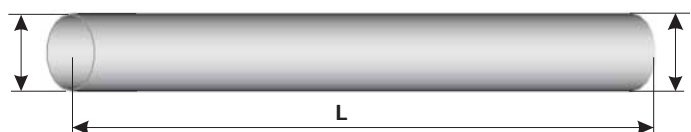

Dia.  
Ext.

Ep : 1,5 mm  
Acier aluminé

Réf. HOBI	L (mm)	Dia. Ext. (mm)
16039	2	50,00
16648	2	60,00
16642	2	63,50
16644	2	65,00
16608	2	70,00
12002	2	75,00
12003	2	76,00
12059	2	80,00
12019	2	88,90
12099	2	100,00
12096	2	101,60
12089	2	110,00
12083	2	114,30
12079	2	120,00
12070	2	127,00
12029	2	140,00
12039	2	150,00

## TUBES FLEXIBLES 2 MÈTRES

Vendus par Longueur de 2 mètres  
Pour avoir le diamètre extérieur ajouter 4 mm au diamètre intérieur

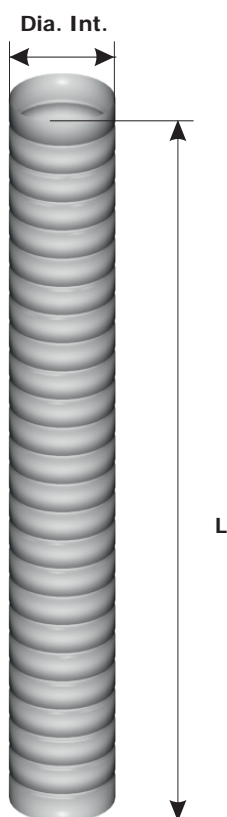

L = longueur du tube comprimé

Remarque : un flexible se monte souple  
(ni tendu - ni comprimé).

Flex. INOX		Flex. Électrozingués	
Réf. HOBI	Dia. Int. (mm)	Réf. HOBI	Dia. Int. (mm)
12773	25,00	13773	25,00
-	30,00	13775	30,00
12767	32,00	13767	32,00
-	36,00	13763	36,00
12765	39,00	13765	39,00
12728	42,00	13728	42,00
12722	45,00	13722	45,00
-	48,00	13725	48,00
12738	51,00	13738	51,00
12732	54,50	13732	54,50
12730	58,00	13730	58,00
12749	61,00	13749	61,00
12742	64,00	13742	64,00
12743	66,00	-	66,00
12709	70,00	13709	70,00
12704	77,00	13704	77,00
12759	80,00	13759	80,00
-	83,00	13756	83,00
12753	86,00	13753	86,00
12751	90,00	13751	90,00
-	95,00	13713	95,00
12799	101,00	13799	101,00
12797	103,00	13797	103,00
12792	104,00	13792	104,00
12795	108,00	13795	108,00
12789	111,00	13789	111,00
12782	115,00	13782	115,00
12779	121,50	13779	121,50
12774	126,50	13774	126,50
12770	128,00	13770	128,00
12768	131,50	13768	131,50
12729	141,00	13729	141,00
12737	153,50	13737	153,50

## TUBES DROITS MÂLE - FEMELLE

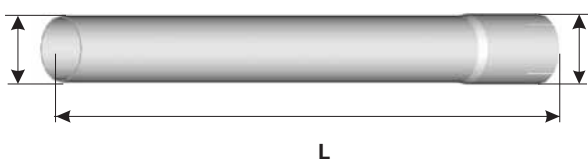
	Réf. HOBI	L (m)	Dia. Int. (mm)	Dia. Ext. (mm)
	<p>Ep : 1,5 mm Acier aluminé</p>	16838	1,5	51,30
16830		1,5	57,60	57,10
16849		1,5	60,50	60,00
16842		1,5	64,00	63,50
16809		1,5	70,30	69,80
16804		1,5	76,70	76,20
16851		1,5	89,40	88,90
16897		1,5	102,10	101,60
16895		1,5	108,50	108,00
16889		1,5	111,00	110,00
16882		1,5	114,80	114,30
16879		1,5	121,00	120,00
16870		1,5	128,00	127,00

## TUBES FLEXIBLES 1 MÈTRE

Vendus par Longueur de 1 mètre  
Pour avoir le diamètre extérieur ajouter 4 mm au diamètre intérieur

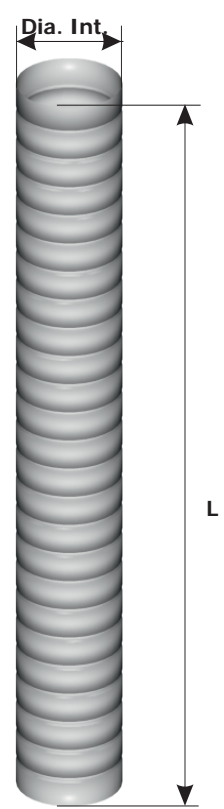
	Flex. INOX		Flex. ÉLECTROZINGUÉS	
	Réf. HOBI	Dia. Int. (mm)	Réf. HOBI	Dia. Int. (mm)
<p>L = longueur du tube comprimé</p> <p>Remarque : Un flexible se monte souple (ni tendu - ni comprimé).</p>	12873	25,00	13873	25,00
	-	30,00	13875	30,00
	12867	32,00	13867	32,00
	12863	36,00	13863	36,00
	12865	39,00	13865	39,00
	12828	42,00	13828	42,00
	12822	45,00	13822	45,00
	12825	48,00	13825	48,00
	12838	51,00	13838	51,00
	-	54,50	13832	54,50
	12830	58,00	13830	58,00
	12849	61,00	13849	61,00
	12842	64,00	13842	64,00
	12840	67,00	13840	67,00
	12809	70,00	13809	70,00
	12804	77,00	13804	77,00
	12859	80,00	13859	80,00
	-	83,00	13856	83,00
	12853	86,00	13853	86,00
	12851	90,00	13851	90,00
	-	95,00	13813	95,00
	12899	101,00	13899	101,00
	12897	103,00	13897	103,00
	12892	104,00	13892	104,00
	12895	108,00	13895	108,00
	12889	111,00	13889	111,00
	12882	115,00	13882	115,00
	12879	121,00	13879	121,50
	12874	126,50	13874	126,50
	12870	128,00	13870	128,00
12868	131,50	13868	131,50	
12829	141,00	13829	141,00	
12837	153,50	13837	153,50	

## TUBES COUDÉS



Ep : 1,5 mm  
Acier aluminé

Réf. HOBI	L (mm)	Dia. int. (mm)
18239	260	50,50
18249	305	60,50
18243	1500	65,50
18209	300	70,50
18203	365	75,50
51411	1130	76,00
18259	340	80,50
18218	360	90,50
18298	375	101,00
18287	535	111,00
59443	535	115,00
18278	515	121,00
18268	500	128,00

## MANCHONS ACCOUPLEMENTS Dia. Int. / Int.

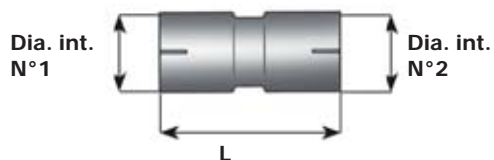

Réf. HOBI	Dia. N°1 (mm)	Dia. N°2 (mm)	L (mm)
16037	51,0	51,0	200
16038	51,0	60,5	200
16049	60,5	64,0	200
16048	60,5	70,5	200
16047	60,5	76,7	200
16031	61,0	61,0	200
16042	64,5	70,8	200
16043	66,0	66,0	200
16009	70,5	76,7	200
16008	71,0	71,0	200
16002	75,5	90,5	200
16006	76,0	76,0	250
16004	76,7	89,5	200
16000	76,7	102,1	200
16058	77,0	77,0	250
16059	80,5	89,5	200
16007	80,5	102,1	200
16001	81,0	81,0	250
16051	89,4	102,1	200
16018	89,4	108,5	200
16017	89,4	110,5	200
16016	89,4	114,8	200
16055	90,0	90,0	250
16012	90,5	114,8	200
16052	101,0	101,0	300
16011	101,0	103,0	200
16099	101,0	114,8	200
16097	102,1	109,0	200
16092	102,1	110,5	200
16086	102,1	114,8	200
16093	102,1	127,5	200
16094	103,0	103,0	300
16091	108,5	110,5	200
16095	108,5	114,8	200
16088	108,5	120,5	200

## SUITE...

Réf. HOBI	Dia. N°1 (mm)	Dia. N°2 (mm)	L (mm)
16087	108,5	127,5	200
16084	110,5	114,8	200
16080	110,5	120,5	200
16085	110,5	127,5	200
16054	111,0	111,0	300
16081	114,8	127,5	200
16073	115,0	115,0	300
16079	120,5	127,5	200
16072	128,0	128,0	200

## MANCHONS/ ACCOUPLEMENTS Dia Int. / Ext.

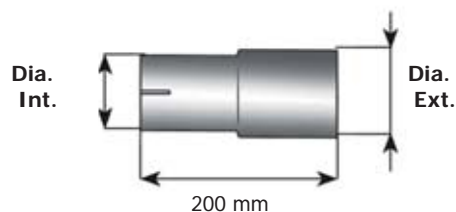

Réf. HOBI	Dia. Int. (mm)	Dia. Ext. (mm)	L (mm)
16046	64,5	70,0	200
16041	70,8	76,2	200
16003	76,7	88,9	200
16053	76,7	101,6	200
16005	89,4	101,6	200
16082	102,1	114,3	200
16773	102,1	127,0	200
16071	114,8	127,0	200

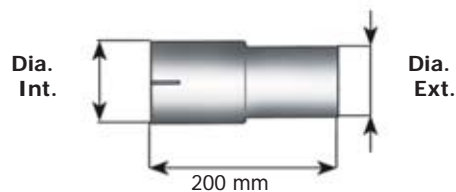

Réf. HOBI	Dia. Int. (mm)	Dia. Ext. (mm)	L (mm)
16019	89,4	76,2	200
16056	102,1	76,2	200
16096	102,1	88,9	200
16089	110,5	101,6	200
16083	114,8	101,6	200
16077	128,0	101,6	200

## CAOUTCHOUCS

M 8

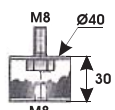

**21190**  
81.96210.052

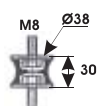

**78577**  
0285530

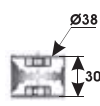

**75560**  
98415197

M 10

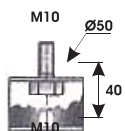

**21565**  
81.96210.0101

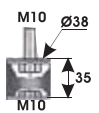

**39139**  
697.987.0139

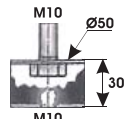

**21189**  
81.96210.0153

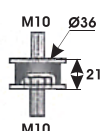

**39189**  
001.987.5340

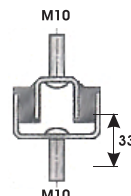

**41592**  
4.771.333.000

M 12

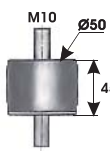

**59121**  
324842

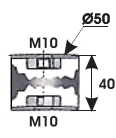

**59138**  
1580440

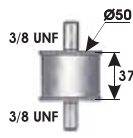

**09590**  
36233 S1

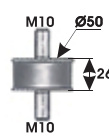

**72196**  
104939-8

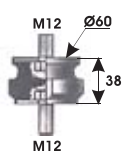

**78579**  
0221342



**59139**  
6850149

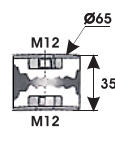

**45199**  
40607

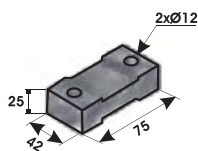

**39187**  
667.490.0037

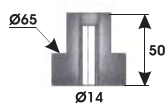

**72197**  
100348-3

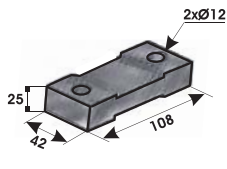

**39192**  
309.490.0037

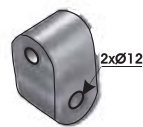

**72192**  
117280-3

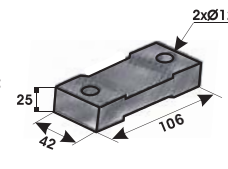

**78575**  
0298390

UNIVERSEL

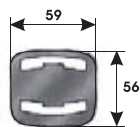

**39591**  
381.492.0082



**39153**  
901.492.0044

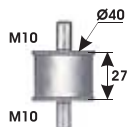

**42592**  
5000750531

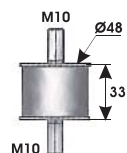

**42580**  
5000750630

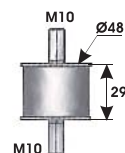

**41580**  
4.771.244.000

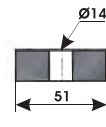

**42598**  
0000689778



**42574**  
5000750518

## PARE FLAMMES « PL » (Poids Lourds)

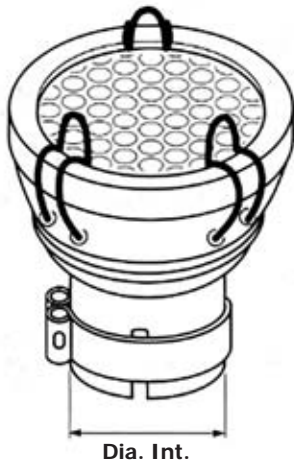

Dia. Int.

### Livré avec :

- Une grille triple épaisseur
- Une grille simple épaisseur
- Un collier à tourillons
- Des bagues de réduction
- Un emballage carton

Réf. HOBI	Dia. Int. (mm)
29594 (*)	45,5 - 50,5
29590	55,5
29595	60,5
29591	65,5
29589	70,5
29588	75,5
29587	80,5
29586	85,5
29582	90,5
29583	95,5
29584	101
29580	106
29585	111
29581	116
29579	121 - 126
29578	131 - 136

### (\*) ADAPTATEUR



Réf. HOBI	Dia. Ext. (mm)	Dia. Int. (mm)
29576	50	45,5

## PARE FLAMMES « VL » (Véhicules Légers)



Dia. Int.

### Livré avec :

- Une grille triple épaisseur
- Une grille simple épaisseur
- Un collier à tourillons
- Des bagues de réduction
- Un emballage carton

Réf. HOBI	Dia. Int. (mm)
29599	32,5 - 39,0
29598	39,5 - 44,0
29597	44,5 - 49,0
29596	49,5 - 54,0
29592	54,5 - 59,0

### KIT Réparation Pare-Flammes : PL

1 grille triple épaisseur



1 grille simple épaisseur



3 crochets  
1 couvercle



Réf. HOBI

29577

### KIT Réparation Pare-Flammes : VL

1 grille triple épaisseur



1 grille simple épaisseur

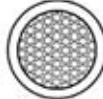

2 crochets  
1 couvercle



Réf. HOBI

29593





## SILENCIEUX STANDARD

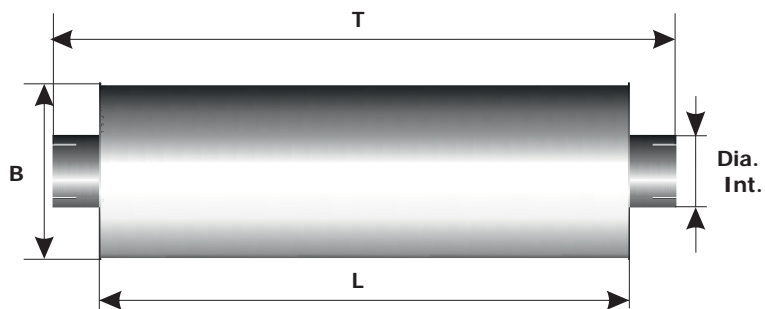

Réf. HOBI	T (mm)	L (mm)	B (mm)	Dia. Int. (mm)
50604	927	800	184	77
50651	927	800	184	89,50
50297	1145	965	184	102
50682	1219	1041	249	115
50670	1219	1041	249	128

## FLEXIBLE ONDULEUX + TRESSE INOX

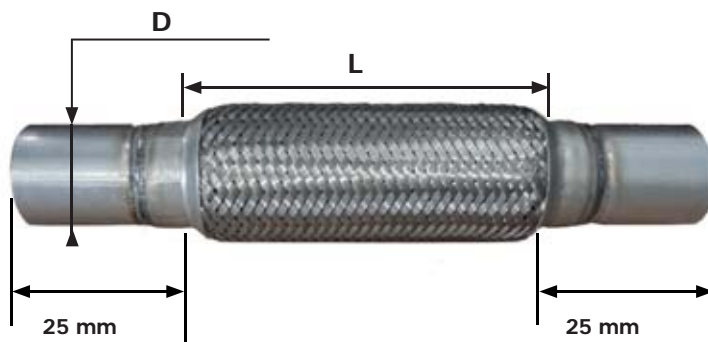

Réf. HOBI	Dia. Ext (mm)	L : (mm)	Réf. HOBI	Dia. Ext (mm)	L : (mm)
111202	40	150	111228	65	250
111205	45	150	131204	77	250
111208	48	200	131208	90	250
111211	51	200	131213	103	300
111216	57	250	131218	115	300
111220	61	250	131223	128	300
111224	63	250	-	-	-

## RACCORDS à 90° MÂLE - FEMELLE

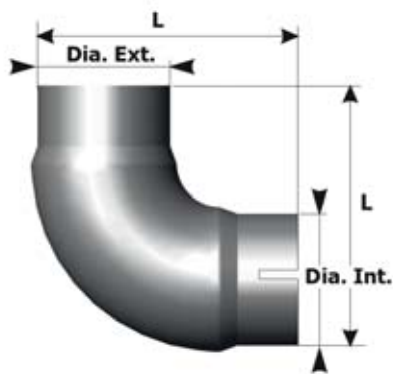

Réf. HOBI	L (mm)	Dia. Ext. (mm)	Dia. Int. (mm)
14938	200	50,00	51,30
14943	200	63,50	64,00
14904	200	76,20	78,80
14951	200	88,90	89,40
14897	200	101,60	102,10
14895	200	108,00	108,50
14882	200	114,30	114,80
14870	200	127,00	128,00

Acier Aluminium - Épaisseur : 1,5 mm

## RACCORDS à 90° MÂLE - MÂLE

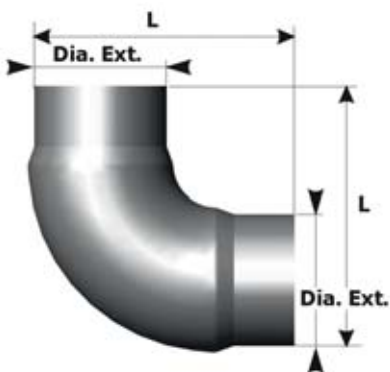

Réf. HOBI	L (mm)	Dia. Ext. (mm)	Dia. Ext. (mm)
14939	200	50,00	50,00
14942	200	63,50	63,50
14903	200	76,20	76,20
14955	200	88,90	88,90
14898	200	101,60	101,60
14890	200	108,00	108,00
14886	200	114,30	114,30
14874	200	127,00	127,00

Acier Aluminium - Épaisseur : 1,5 mm

## RACCORDS à 90° FEMELLE - FEMELLE

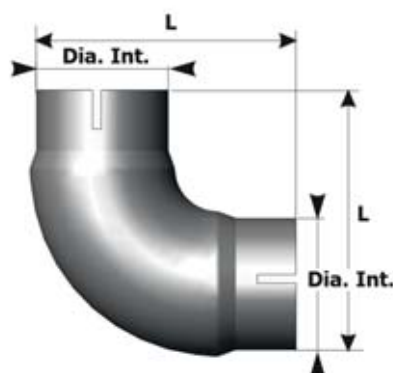

Réf. HOBI	L (mm)	Dia. Int. (mm)	Dia. Int. (mm)
10938	200	51,30	51,30
10943	200	a63,50	63,50
10904	200	76,80	76,80
10951	200	89,40	89,40
10897	200	102,10	102,10
10895	200	108,50	108,50
10889	200	110,50	110,50
10882	200	114,80	114,80
10870	200	128,00	128,00

Acier Aluminium - Épaisseur : 1,5 mm

## GRILLES PARE-CHALEUR TUBES

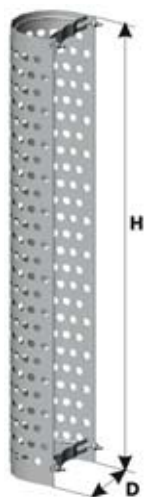

Réf. HOBI	H (mm)	D (mm)
13339	800	50
13349	800	60
13309	800	70
13303	800	75
13357	800	80
13351	800	90
13396	800	100
13389	800	110
13382	800	114
13378	800	120
13375	800	127

Acier Electrozingué

Colliers de fixation fournis - D = Dia. Ext. du tube

## SANGLES POUR SILENCIEUX

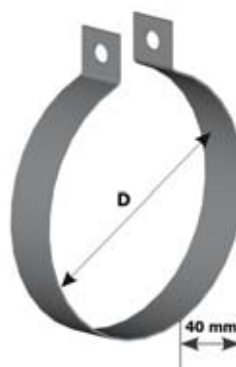

Réf. HOBI	D (mm)
15037	155
15005	178
15052	184
15096	206
15075	228
15032	254
15001	284
15593	300
75599	380

Acier Aluminium

Ép. : 3 mm - D = Dia. Ext. du silencieux

**CHANGEZ POUR HOBI  
ET NE CHANGEZ PLUS**

« Des silencieux à ce prix là ! Ça va faire du bruit... »

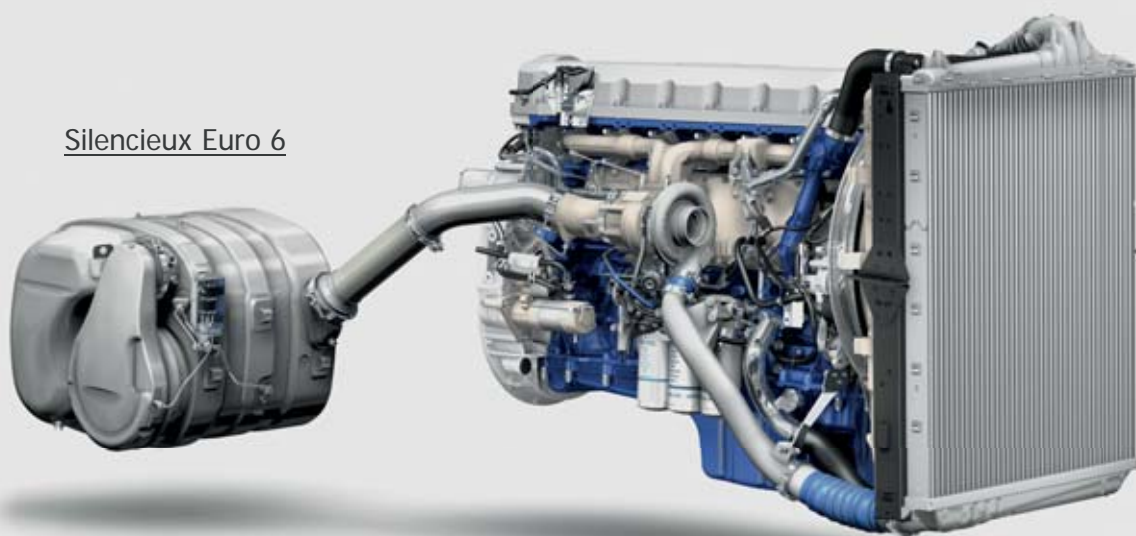

Silencieux Euro 6

#### **SIÈGE SOCIAL HOBI FRANCE**

9, rue Condorcet – Zone industrielle  
94430 Chennevières-sur-Marne  
Tél : 00.33.(0)1.56.31.28.32  
Fax : 00.33.(0)1.56.31.28.33  
Mail : [hobi@hobifrance.com](mailto:hobi@hobifrance.com)  
Web : [www.hobifrance.com](http://www.hobifrance.com)

Pour : informations techniques, ouverture de comptes, accord de retour pièces, prix, etc.

#### **DÉPÔT HOBI FRANCE**

P.A de Roubaix – Est  
16, rue du Trieu du Quesnoy  
59115 LEERS - France  
Tél : 00.33.(0)3.20.60.33.33  
Fax : 00.33.(0)3.20.95.90.00  
Mail : [cdebarre59@orange.fr](mailto:cdebarre59@orange.fr)  
8h30 - 12h et 14h – 18h

Pour : commandes, montant d'un port  
Informations sur les livraisons, etc.

**hObi**®

ÉCHAPPEMENTS PL  
RÉSEROIRS D'AIR PL  
RÉSEROIRS DE CARBURANT PL